



ZESKANTTAPBOUT

~ISO-4017 DIN-933	
	
BLANK	
ST-8.8	
933000880	M-

DIN	DIN-933
EN	-
ISO	ISO-4017
CODE	93300
MATERIAAL	STAAL 8.8
OPPERVLAKTE	BLANK
CODE	0880
METRISCH	M-
VOORBEELD M-3X6	
CODE	030006
BESTELCODE	93300 0880 030006

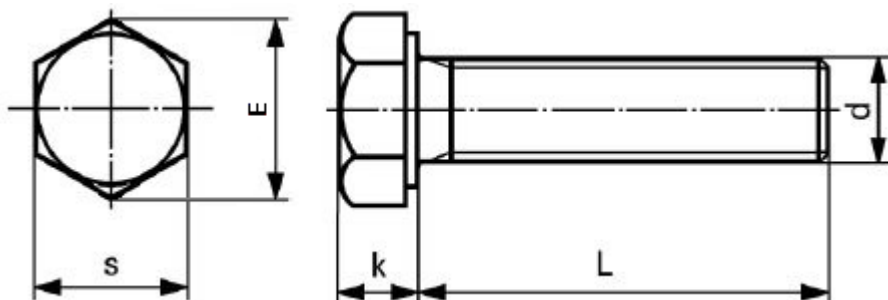

D	K	E	S	D	K	E	S
M3	2	6,01	5,5	M20	12,5	33,53	30
M4	2,8	7,66	7	M22	14	35,72	32
M5	3,5	8,79	8	M24	15	39,98	36
M6	4	11,05	10	M27	17	45,2	41
M8	5,3	14,38	13	M30	18,7	50,85	46
M10	6,4	18,9	17	M33	21	55,37	50
M12	7,5	21,1	19	M36	22,5	60,79	55
M14	8,8	24,49	22	M42	26	71,3	65
M16	10	26,75	24	M48	30	82,6	75
M18	11,5	30,14	27				