

ZESKANTMOER

LAAG

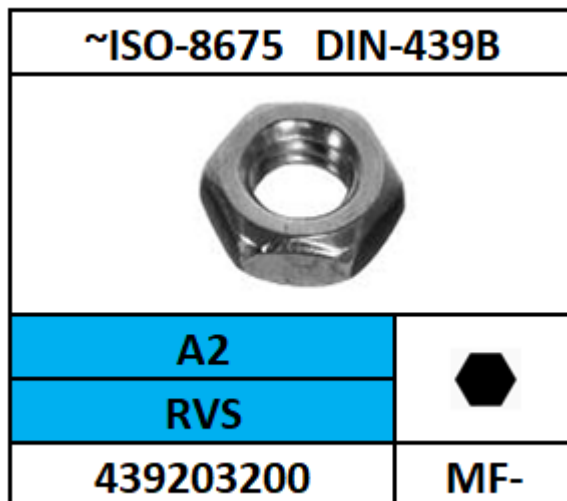

DIN	DIN-439B
EN	-
ISO	ISO-8675
CODE	43900
MATERIAAL	ROESTVAST STAAL A2
OPPERVLAKTE	-
CODE	3200
METRISCH	M-
VOORBEELD MF-8X1	
CODE	808010
BESTELCODE	43900 3200 808010

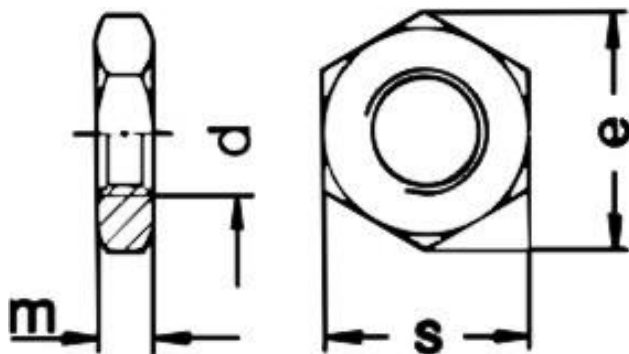

D	S	E	M	D	S	E	M
M2	4	4.32	1.2	M16	24	26.75	8
M3	5.5	6.01	1.8	M18	27	29.56	9
M4	7	7.66	2.2	M20	30	32.95	10
M5	8	8.79	2.7	M22	32	35.03	11
M6	10	11.05	3.2	M24	36	39.55	12
M8	13	14.38	4	M27	41	45.2	13.5
M10	17	18.9	5	M30	46	50.85	15
M12	19	21.1	6	M33	50	55.37	16.5
M14	22	24.49	7	M36	55	60.79	18